

ARMCHAIR

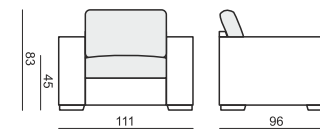

2 SEATER

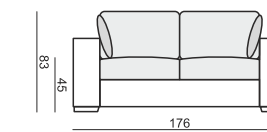

3 SEATER

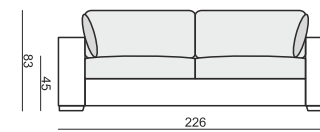

3,5 SEATER

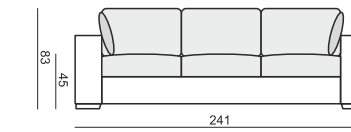

FOOTSTOOL

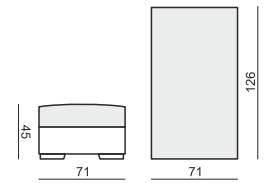

EXAMPLE OF LEATHER COVER

ARMCHAIR

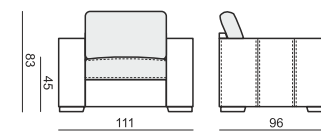

SET 1

2 SEATER LEFT + CORNER 90° + 2 SEATER RIGHT

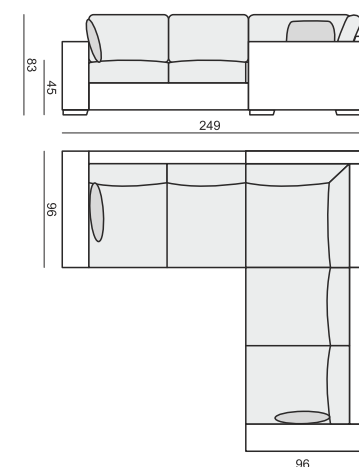

SET 2 RIGHT (or LEFT)

3 SEATER LEFT (or RIGHT) + CORNER 90° + 2 SEATER RIGHT (or LEFT)

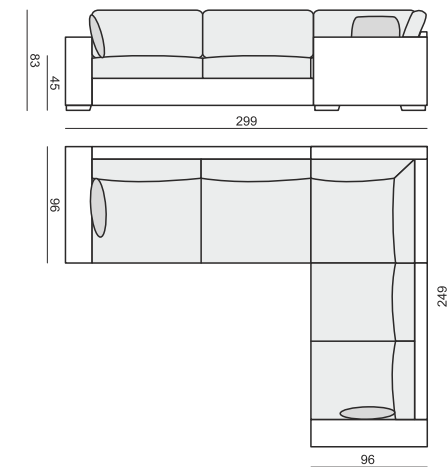

3 SEATER SOFA BED

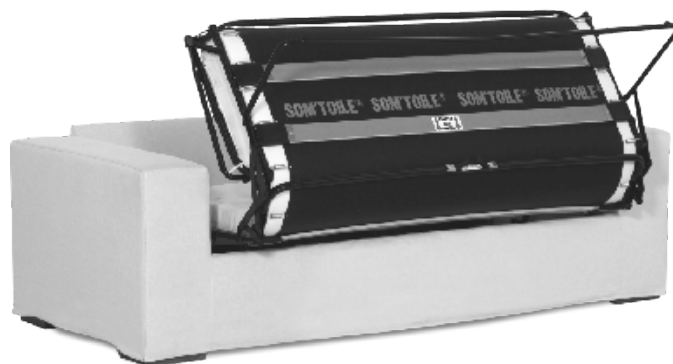
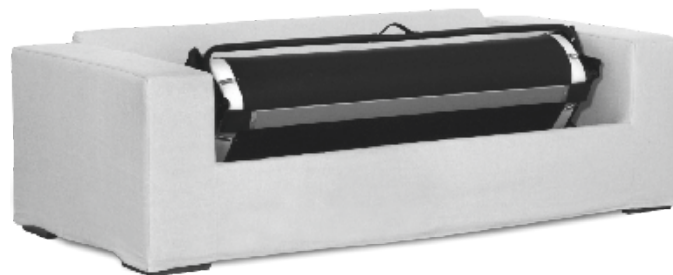
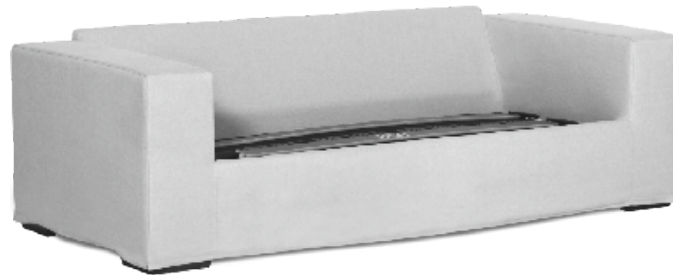

2 SEATER SOFA BED

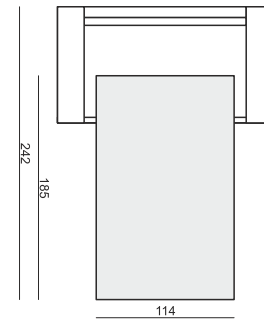
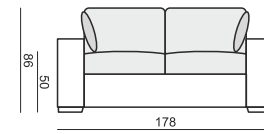

3 SEATER SOFA BED

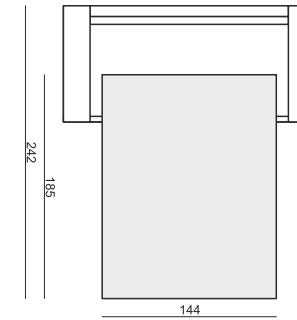
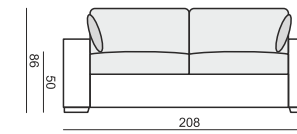

UPHOLSTERY

FABRIC: FC - fix cover or LC - loose cover and LEATHER: FC - fix cover

FEET

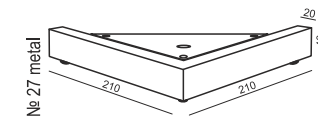
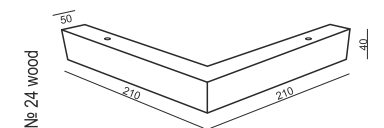
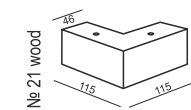
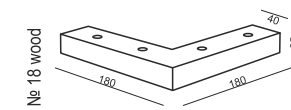

Available feet for sofa bed - minimum 40 mm high.

STANDARD COMFORT

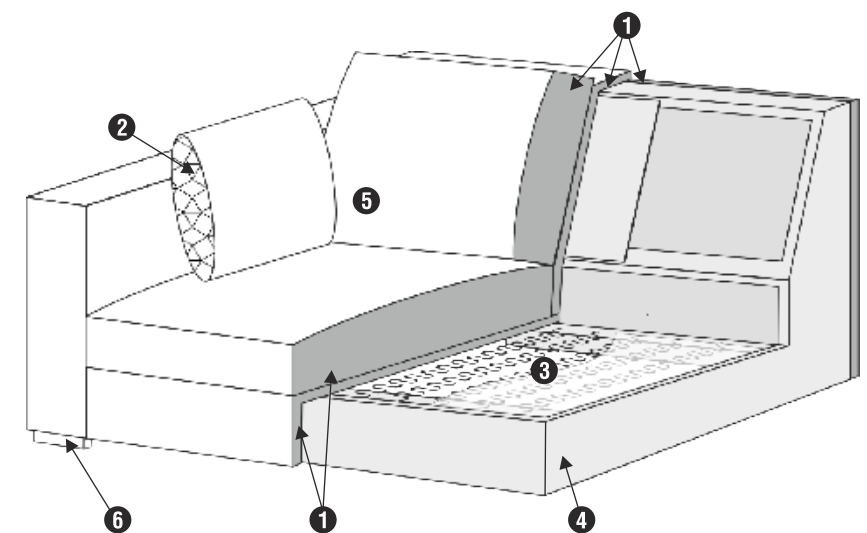

1. polyurethane foam / high resilient polyurethane foam
2. silicone balls
3. springs
4. solid wood and wood based elements
5. fabric or leather
6. solid wood legs