

ARMCHAIR

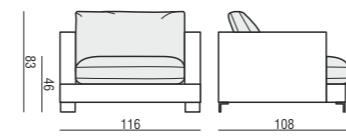

ARMCHAIR LEFT (or RIGHT)

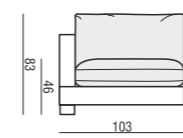

ARMCHAIR without ARMRESTS

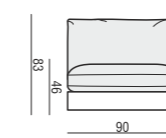

ARMCHAIR WIDE

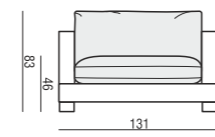

ARMCHAIR WIDE LEFT (or RIGHT)

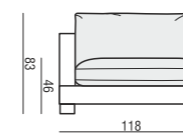

ARMCHAIR WIDE without ARMRESTS

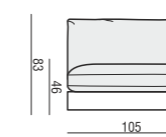

2 SEATER

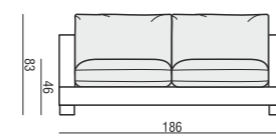

2 SEATER LEFT (or RIGHT)

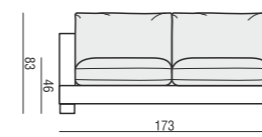

2 SEATER without ARMRESTS

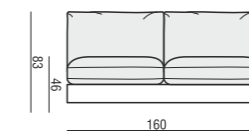

3 SEATER or 3 SEATER TWO PARTS

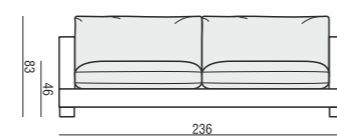

3 SEATER LEFT (or RIGHT)

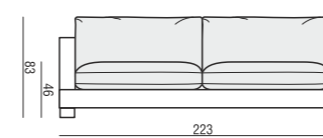

3 SEATER without ARMRESTS

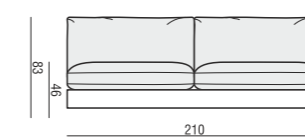

DIVAN LEFT (or RIGHT) or DIVAN TWO PARTS LEFT (or RIGHT)

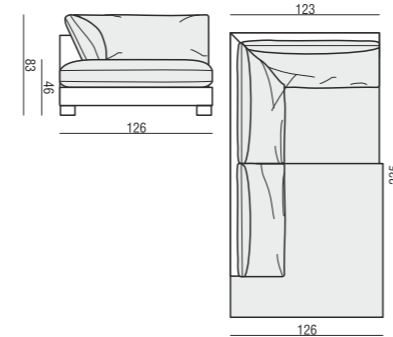

BENCH LEFT (or RIGHT)

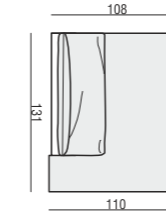

CORNER 35° LEFT (or RIGHT)

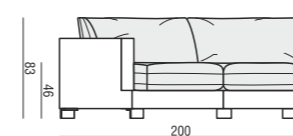

CORNER 90°

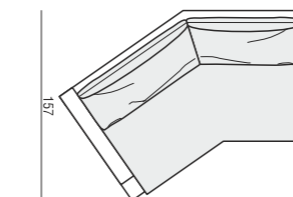
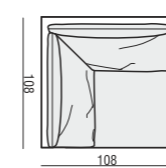

SITS reserves the right to change construction of products and components used due to improving durability of product and customer satisfaction without any further notice. Explicit ±2 cm tolerance of all elements sizes.

FOOTSTOOL 97x82

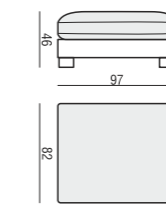

FOOTSTOOL 107x92

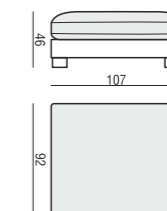

FOOTSTOOL 122x92

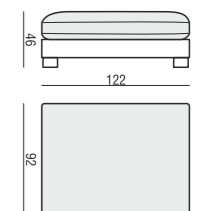

ACCESSORIES

ARMREST PROTECTOR

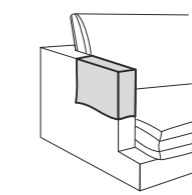

HEADREST with ROLL L-70

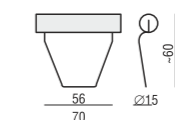

**SET 1
3 SEATER LEFT + ARMCHAIR WIDE RIGHT**

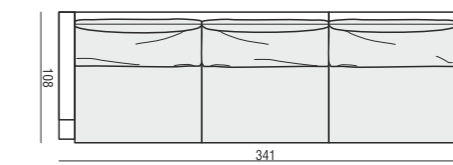

**SET 2 LEFT (or RIGHT)
DIVAN LEFT (or RIGHT) + 2 SEATER RIGHT (or LEFT)**

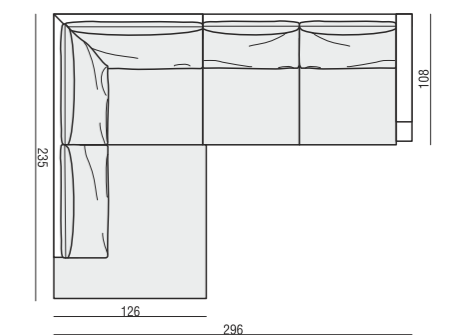

**SET 3 LEFT (or RIGHT)
DIVAN LEFT (or RIGHT) + 3 SEATER RIGHT (or LEFT)**

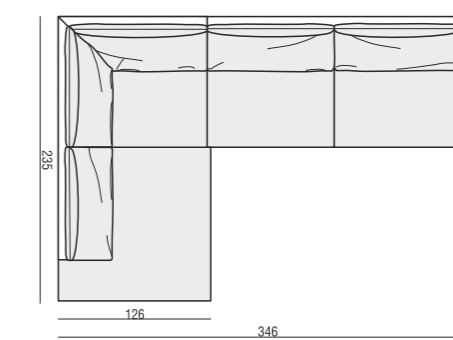

**SET 4 LEFT (or RIGHT)
DIVAN LEFT (or RIGHT) + ARMCHAIR without ARMRESTS + 2 SEATER RIGHT (or LEFT)**

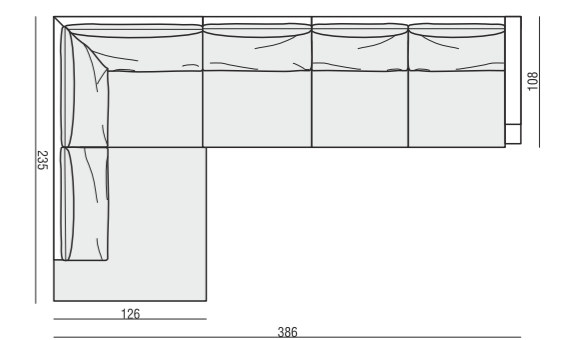

ASPEN

www.sits.eu
DECEMBER 2016

SET 5 LEFT (or RIGHT)
DIVAN LEFT (or RIGHT) + ARMCHAIR without ARMRESTS
+ 3 SEATER RIGHT (or LEFT)

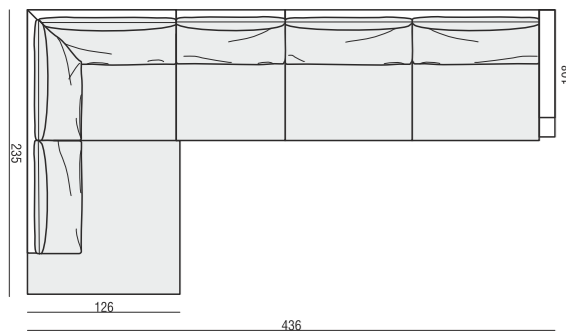

SET 6 LEFT (or RIGHT)
DIVAN LEFT (or RIGHT) + ARMCHAIR WIDE without ARMRESTS
+ 2 SEATER RIGHT (or LEFT)

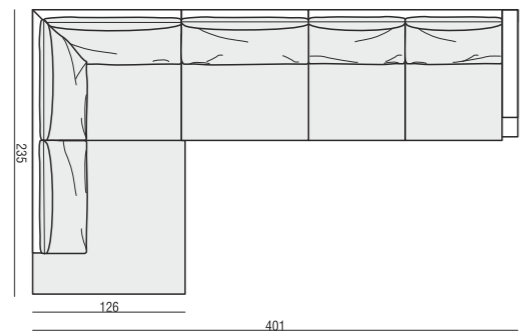

SET 7 LEFT (or RIGHT)
DIVAN LEFT (or RIGHT) + ARMCHAIR WIDE without ARMRESTS
+ 3 SEATER RIGHT (or LEFT)

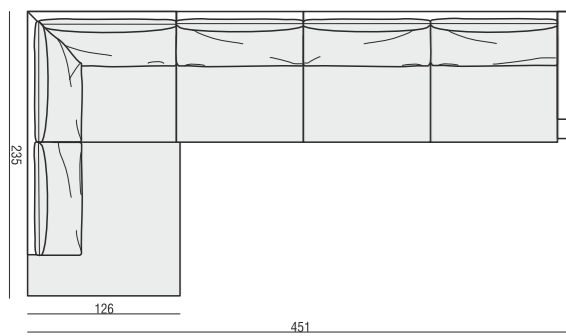

SET 8 LEFT (or RIGHT)
CORNER 35° LEFT (or RIGHT) + ARMCHAIR RIGHT (or LEFT)

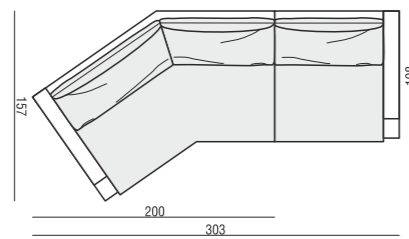

SET 9 LEFT (or RIGHT)
CORNER 35° LEFT (or RIGHT) + 2 SEATER RIGHT (or LEFT)

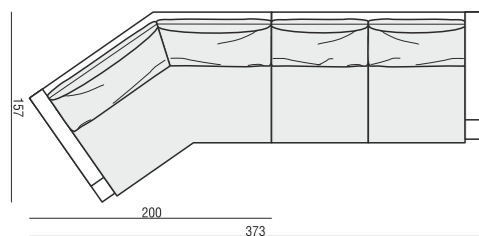

SET 10 LEFT (or RIGHT)
CORNER 35° LEFT (or RIGHT) + 3 SEATER RIGHT (or LEFT)

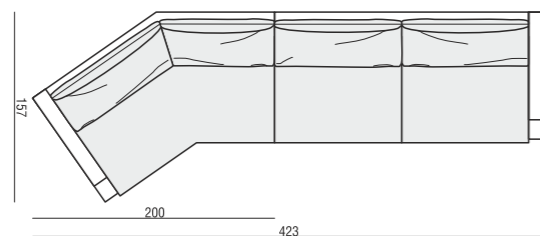

SET 11 LEFT (or RIGHT)
CORNER 35° LEFT (or RIGHT) + ARMCHAIR without ARMRESTS
+ 2 SEATER RIGHT (or LEFT)

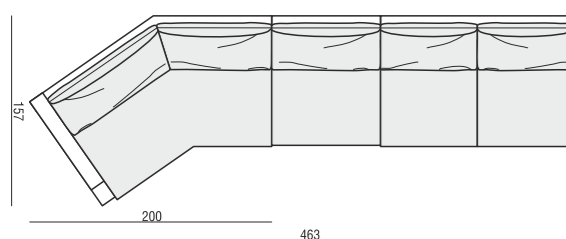

ASPEN

SET 12 LEFT (or RIGHT)
CORNER 35° LEFT (or RIGHT) + ARMCHAIR without ARMRESTS
+ 3 SEATER RIGHT (or LEFT)

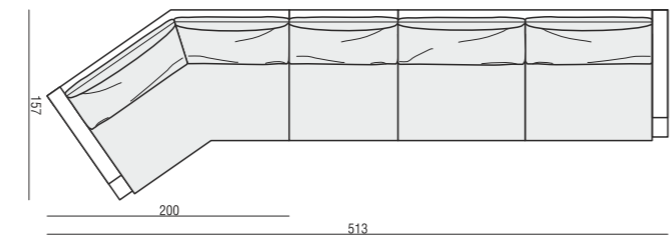

SET 13 LEFT (or RIGHT)
CORNER 35° LEFT (or RIGHT) + ARMCHAIR WIDE without ARMRESTS + 2 SEATER RIGHT (or LEFT)

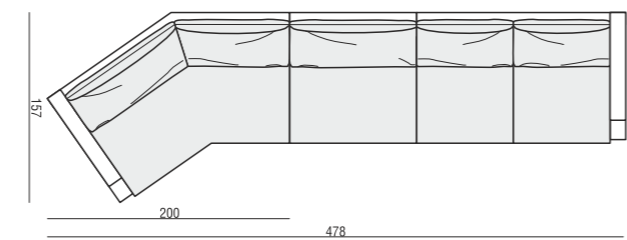

SET 14 LEFT (or RIGHT)
CORNER 35° LEFT (or RIGHT) + ARMCHAIR WIDE without ARMRESTS + 3 SEATER RIGHT (or LEFT)

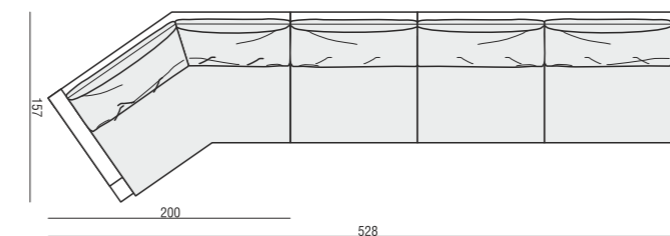

SET 15
DIVAN LEFT + 3 SEATER without ARMRESTS + DIVAN RIGHT

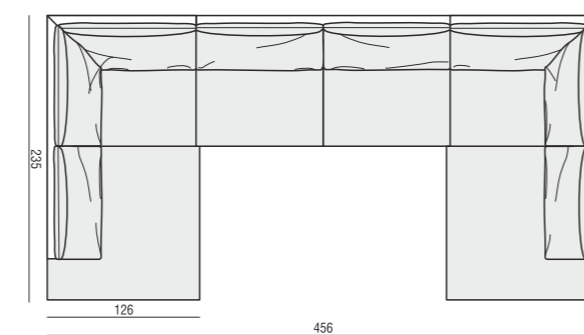

SET 16 LEFT (or RIGHT)
BENCH LEFT (or RIGHT) + CORNER 90° + 3 SEATER RIGHT (or LEFT)

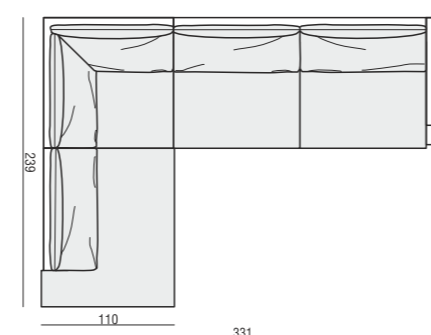

SITS reserves the right to change construction of products and components used due to improving durability of product and customer satisfaction without any further notice. Explicit ±2 cm tolerance of all elements sizes.



UPHOLSTERY FABRIC: FC - fix cover

FEET

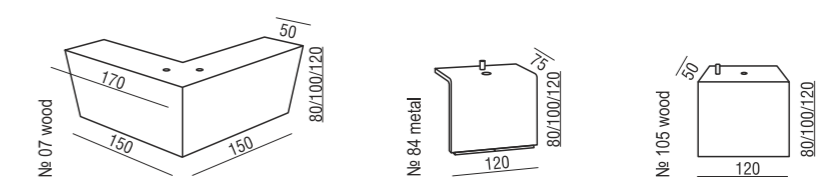

LUX COMFORT

1. polyurethane foam/high resilient polyurethane foam
2. cushion chamber with mix of feather and silicone balls
3. upholstery belts
4. FSC® certified solid wood and wood based elements
5. fabric
6. FSC® certified solid wood or metal legs

