

**SITS**  
— *comfortable life*



---

cocktail  
& design

LASSE

# LASSE

SITS reserves the right to change construction of products and components used due to improving durability of product and customer satisfaction without any further notice. Explicit  $\pm 2$  cm tolerance of all elements sizes.

www.sits.eu  
FEBRUARY 2016

## 2 SEATER

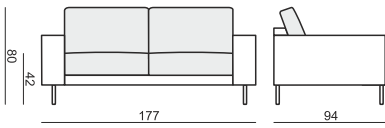

## 2,5 SEATER

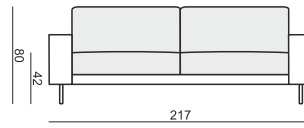

## 3 SEATER

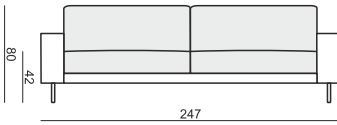

## FOOTSTOOL

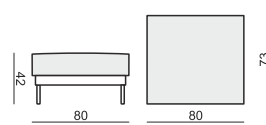

## ARMRESTS

### ARMREST I

cm 91 x 8 x 40 H

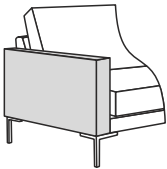

### ARMREST II

cm 91 x 19 x 40 H

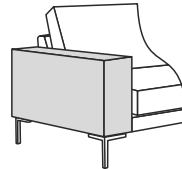

Drawings show combinations with armrest II. Combinations with armrest I are properly shorter in width.

## UPHOLSTERY

FABRIC: FC - fix cover

## FEET

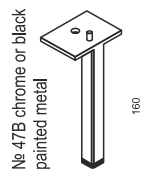

No 47B chrome or black painted metal

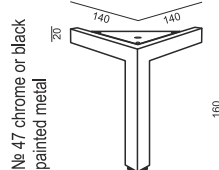

No 47 chrome or black painted metal

THERE ARE 2 OPTIONS TO PLACE THE LEGS:  
under armrest      under frame

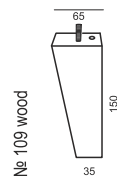
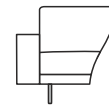
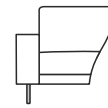

No 109 wood

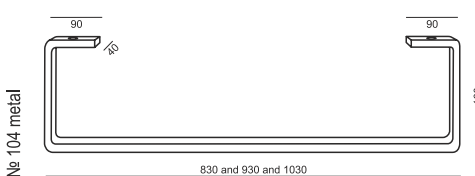

No 104 metal

830 and 930 and 1030

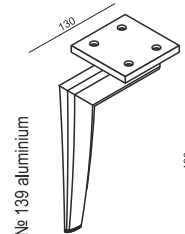

No 139 aluminium

## STANDARD COMFORT (DYNAFLEX INSIDE)

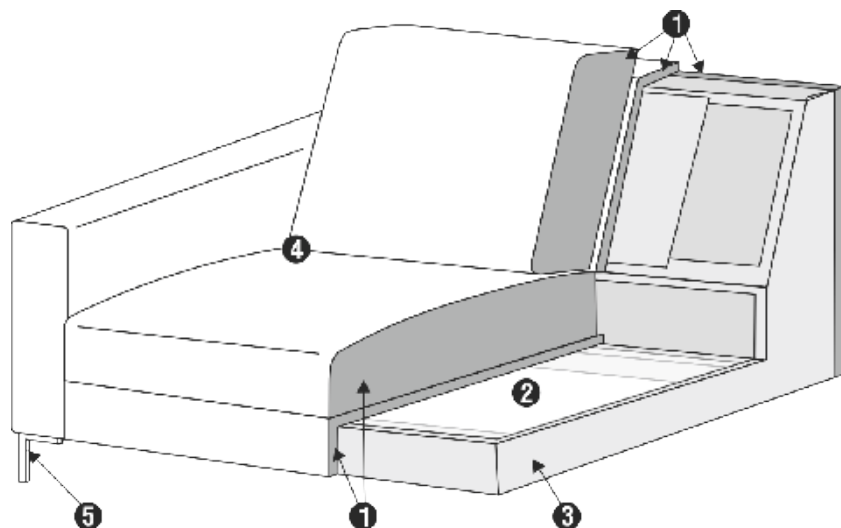

1. polyurethane foam/high resilient polyurethane foam
2. dynaflex - elastic fabric
3. solid wood and wood based elements
4. fabric
5. solid wood/ metal legs