

SITS
— comfortable life

LINDA

All elements can exist as the freestanding.
Unlimited possibilities of sets arrangements - easy assembling system.

www.sits.eu
JANUARY 2017

ELEMENT 80

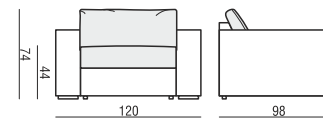

ELEMENT 80 LEFT (or RIGHT)

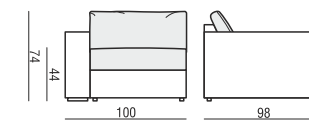

ELEMENT 80 without ARMRESTS

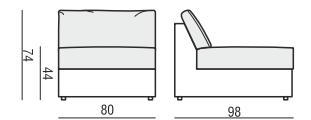

ELEMENT 93

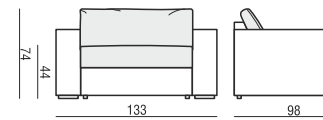

ELEMENT 93 LEFT (or RIGHT)

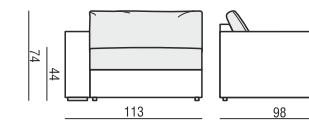

ELEMENT 93 without ARMRESTS

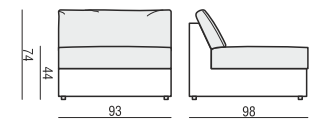

ELEMENT 126

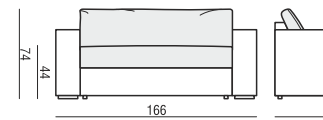

ELEMENT 126 LEFT (or RIGHT)

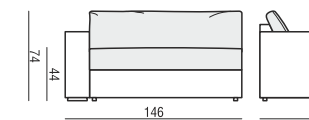

ELEMENT 126 without ARMRESTS

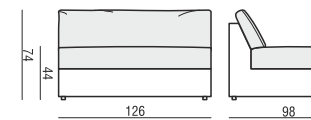

2,5 SEATER

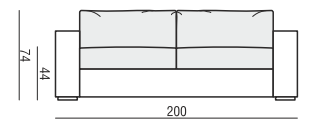

2,5 SEATER LEFT (or RIGHT)

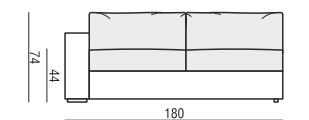

2,5 SEATER without ARMRESTS

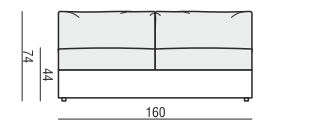

3 SEATER

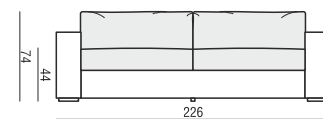

3 SEATER LEFT (or RIGHT)

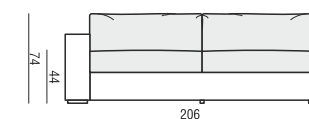

3 SEATER without ARMRESTS

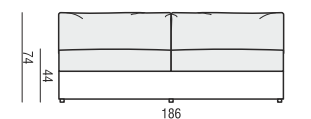

CHAISELONGUE 80 LEFT (or RIGHT)

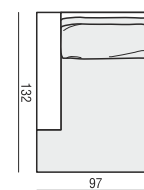

CHAISELONGUE 93 LEFT (or RIGHT)

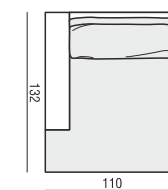

CORNER 90°

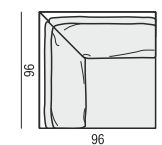

tea
& book

LINDA

FOOTSTOOL 80x98

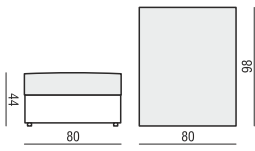

FOOTSTOOL 93x98

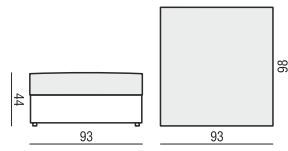

FOOTSTOOL 110x98

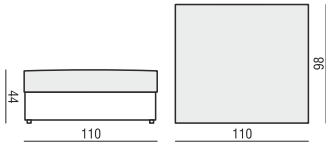

FOOTSTOOL 143x98

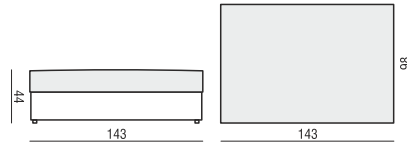

ARMREST

cm 20 x 96 x 54
movable armrest at any time, universal for all elements and purposes (left and right)

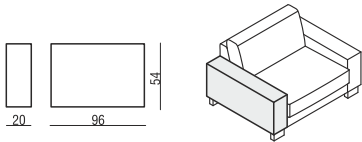

ALL ELEMENTS AVAILABLE WITH SQUARE BACK CUSHIONS

BACK CUSHION 50x32

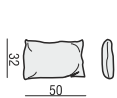

BACK CUSHION 40x40

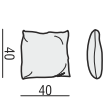

BACK CUSHION 45x45

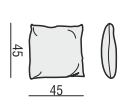

BACK CUSHION 55x55

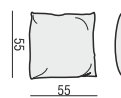

BACK CUSHION 60x60

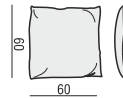

EXAMPLE

ELEMENT 126 LEFT + ELEMENT 126 RIGHT
with 4x CUSHIONS 55x55 + 2x CUSHIONS 60x60

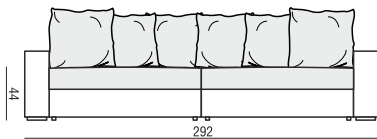

UNLIMITED POSSIBILITIES OF COMBINATIONS, BELOW EXAMPLE ARRANGEMENTS

SET LEFT (or RIGHT)

CHAISELONGUE 93 LEFT (or RIGHT) + 3 SEATER RIGHT (or LEFT)

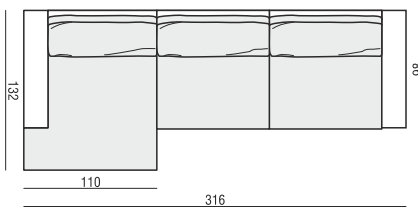

SET

3 SEATER LEFT + CORNER 90° + 3 SEATER RIGHT

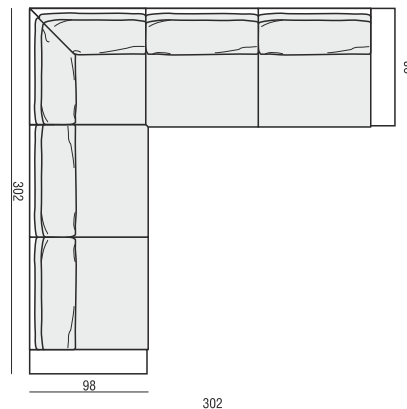

SITS reserves the right to change construction of products and components used due to improving durability of product and customer satisfaction without any further notice.
Explicit ±2 cm tolerance of all elements sizes.

SET

CHAISELONGUE 80 LEFT (or RIGHT) + 2,5 SEATER without ARMRESTS
+ CORNER 90° + ELEMENT 80 RIGHT (or LEFT)

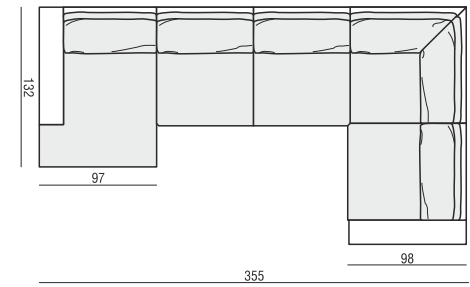

SET RIGHT (or LEFT)

ELEMENT 126 LEFT (or RIGHT) + FOOTSTOOL 143
+ ELEMENT 126 RIGHT (or LEFT)

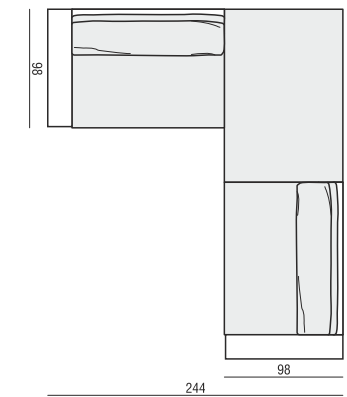

UPHOLSTERY

FABRIC: FC - fix cover or LC- loose cover

FEET

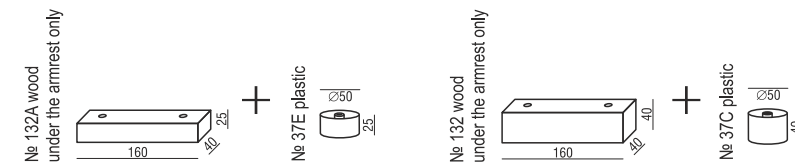

STANDARD COMFORT

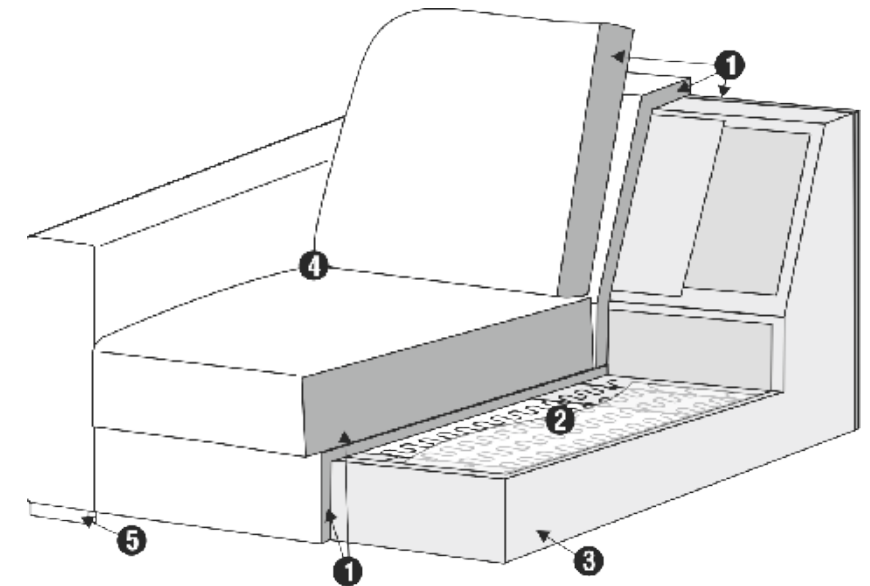

1. polyurethane foam/ high resilient polyurethane foam
2. springs
3. solid wood and wood based elements
4. fabric
5. solid wood/ plastic legs

PREMIUM COMFORT

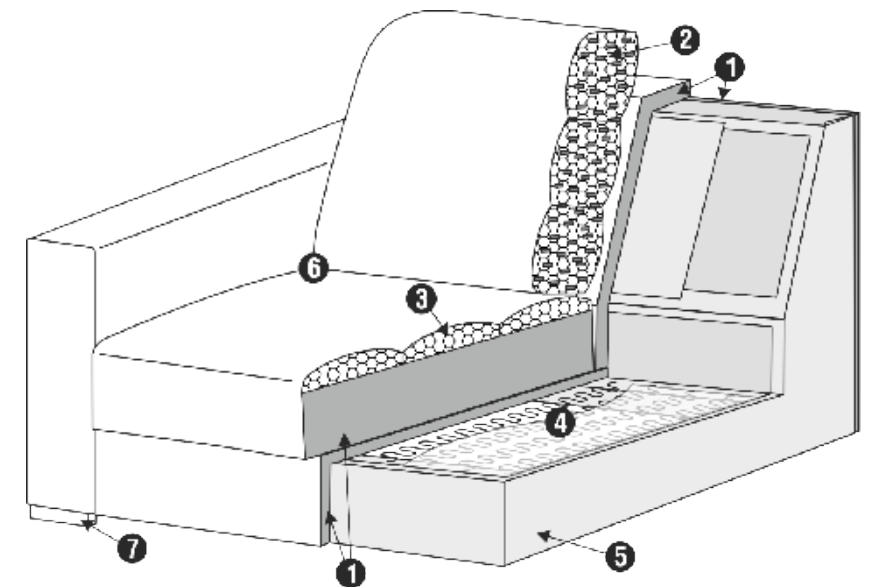

1. polyurethane foam/ high resilient polyurethane foam
2. foam flakes with silicone balls
3. silicone balls
4. springs
5. solid wood and wood based elements
6. fabric
7. solid wood/ plastic legs